



NEW STERN INTERNATIONAL

CARATTERISTICHE TECNICHE

MOMENTO MAX SOLLEVAMENTO	156 kNm
ROTAZIONE	410°
MOMENTO DI ROTAZIONE	26 kNm
PRESSIONE DI ESERCIZIO	306 bar
PORTATA AL DISTRIBUTORE	34 l/min

TECHNICAL DATA

MAX LIFTING MOMENT	156 kNm
SLEWING	410°
SLEWING MOMENT	26 kNm
WORKING PRESSURE	306 bar
DELIVERY TO THE DISTRIBUTOR	34 l/min

CARACTERISTIQUES TECHNIQUES

MOMENT MAX DE LEVAGE	156 kNm
ROTATION	410°
MOMENT DE ROTATION	26 kNm
PRESSION DE TRAVAIL	306 bar
DEBIT AU DISTRIBUTEUR	34 l/min

DATOS TECNICOS

MOMENTO DE ELEVACION	156 kNm
GIRO	410°
MOMENTO DE GIRO	26 kNm
PRESION DE TRABAJO	306 bar
CAUDAL AL DISTRIBUIDOR	34 l/min

TECHNISCE ANGABEN

MAX HUBMOMENT	156 kNm
SCHWENKBEREICH	410°
DREHMOMENT	26 kNm
DRUCK	306 bar
DURCHFLUSS ZUM STELIERBLOCK	34 l/min

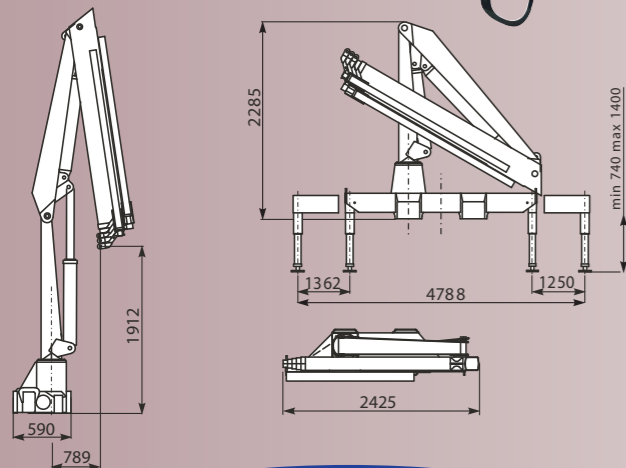

S 19000.4

kg	6060	2860	1800	1330	1040	860
m	2.15	4.85	6.80	8.75	10.80	12.90
lb	3332	5886	3960	2936	2388	1892
ft	7.06	15.90	22.30	28.70	35.43	40.32

kg 1750 (3860 lb)

PESO CON STABILIZZATORI
WEIGHT WITH STABILIZERS
PESO CON ESTABILIZADORES
POIDS AVEC STABILISATEURS
GEWICHT MIT FÜSSE

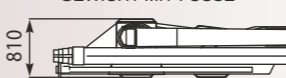

kg 1950 (4990 lb)

PESO CON STABILIZZATORI
WEIGHT WITH STABILIZERS
PESO CON ESTABILIZADORES
POIDS AVEC STABILISATEURS
GEWICHT MIT FÜSSE

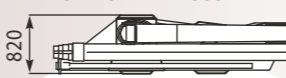

S 19000.6

kg	5950	2600	1700	1200	850	700	580	500
m	2.15	4.85	6.80	8.75	10.80	12.90	14.95	17.00
lb	3090	5720	3740	2640	1870	1540	1276	1100
ft	7.06	15.90	22.30	28.70	35.43	42.32	49.04	55.76

S 19000 + J 15.2

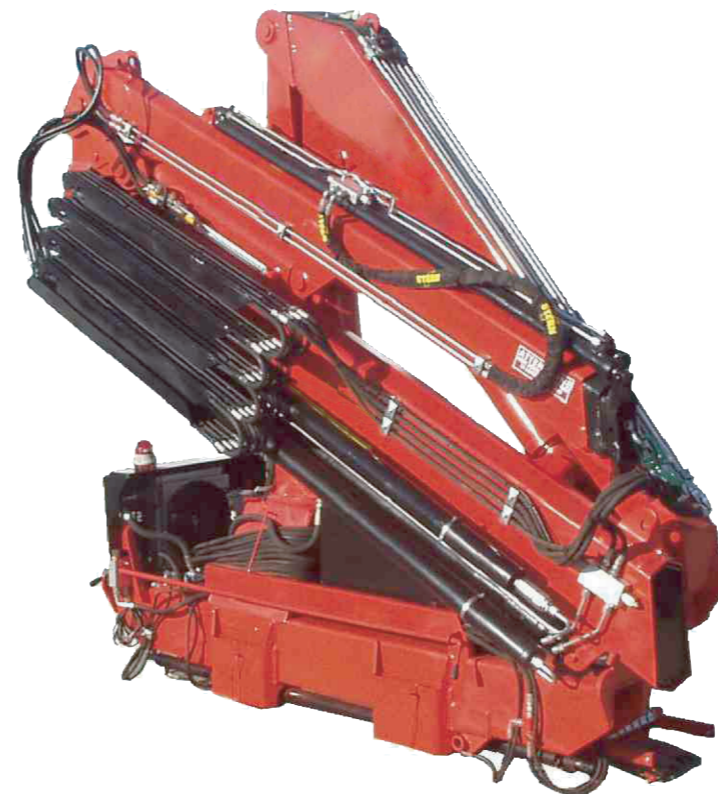

CARATTERISTICHE TECNICHE (J15)

MOMENTO MAX SOLLEVAMENTO	43.6 kNm
PRESSIONE DI ESERCIZIO	275 bar
PESO ANTENNA	360 kg

TECHNICAL DATA (J15)

MAX LIFTING MOMENT	43.6 kNm
WORKING PRESSURE	275 bar
JIB WEIGHT (/ 2)	360 kg

CARACTERISTIQUES TECHNIQUES (J15)

MOMENT MAX DE LEVAGE	43.6 kNm
PRESSION DE TRAVAIL	275 bar
POIDS JIB	360 kg

DATOS TECNICOS (J15)

MOMENTO DE ELEVACION	43.6 kNm
PRESION DE TRABAJO	275 bar
PESO JIB	360 kg

TECHNISCE ANGABEN (J15)

MAX HUBMOMENT	43.6 kNm
DRUCK	275 bar
JIB GEWICHT	360 kg

MAX LOAD J10/2

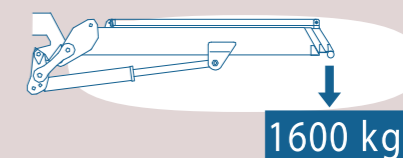

S 19000.3 + J 15.2

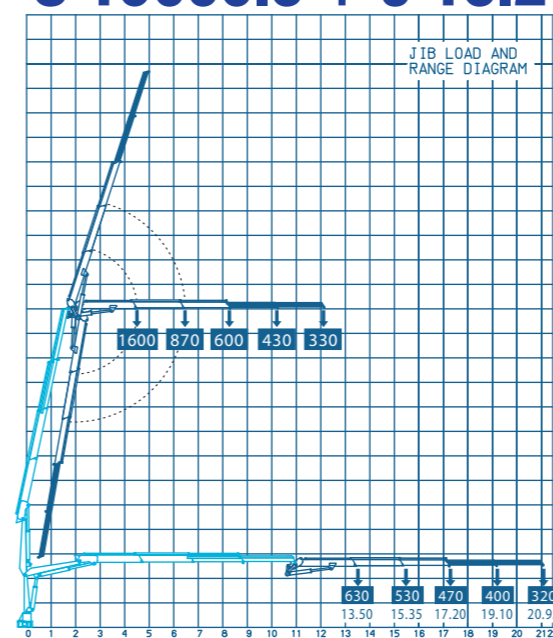

S 19000.4 + J 15.2

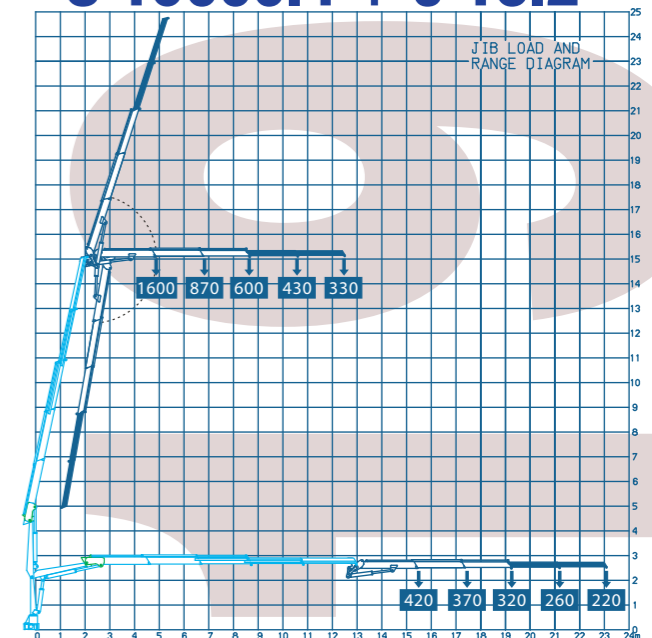

S 19000.3 + J 15.2

kg	530	430	380	320	280
m	13.50	15.35	17.20	19.10	20.95

S 19000.4 + J 15.2

kg	330	270	230	190	170
m	15.60	17.45	19.30	21.20	23.10

NEW STERN INTERNATIONAL



Via Bovi Campeggi, 6
40131 Bologna
Tel +39 051/523517
email: sterninternational@libero.it